

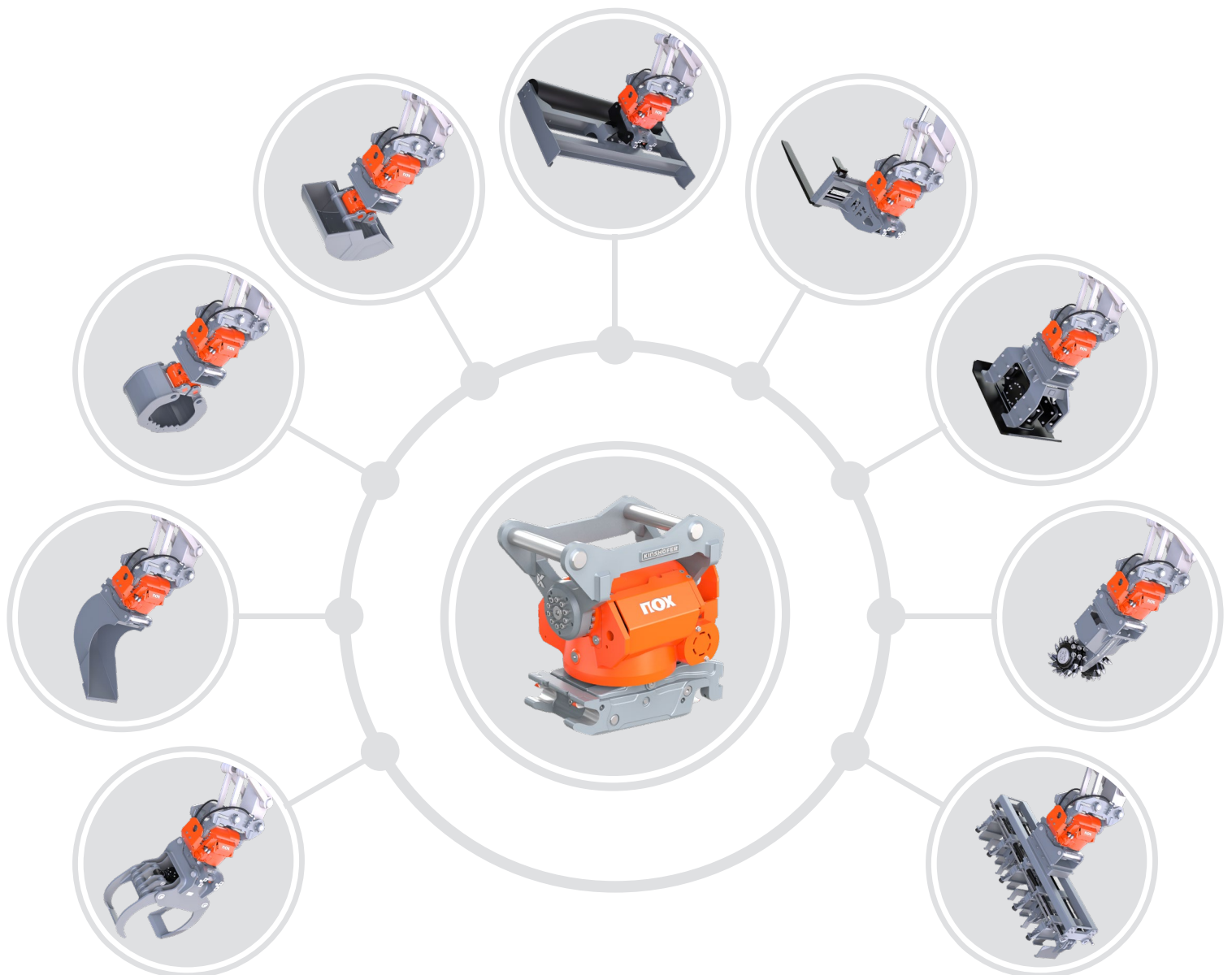

**KINSHOFER**  
crane and excavator attachments

# NOX Tiltrotators and Accessories



**nox TILTROTATORS**

With our Tiltrotator, your attachments can be rotated by 360° continuously and tilted by 50° to both sides. Therefore, the efficiency of your machine will be increased dramatically as time and resources will be saved.

**FOUR FACTS ABOUT THE USE OF TILTROTATORS:**

**PRODUCTIVITY AND PROFITABILITY**

*MANAGE THE SAME AMOUNT OF WORK IN LESS TIME.*

**SAFETY**

*THE NOX TILTROTATOR COMPLIES WITH ALL CURRENT SAFETY REGULATIONS AND HELPS THE OPERATOR AND SURROUNDING WORKFORCE TO ACHIEVE AN ACCIDENT-FREE ENVIRONMENT.*

**VERSATILITY AND FLEXIBILITY**

*INCREASE THE USE OF YOUR MACHINE DRAMATICALLY AND ACCEPT MORE JOBS. ESPECIALLY IN CONJUNCTION WITH THE NOX.*

**READY FOR THE FUTURE**

*THE NOX TILTROTATOR COMES GPS-READY WITH ITS VERY MODERN NOXPROP+ CONTROL SYSTEM. THE MOST COMMON 3D MACHINE CONTROL SYSTEMS CAN BE IMPLEMENTED. EVEN RETROACTIVELY.*



**2 YEARS WARRANTY**  
NOX TILTROTATORS

It is our goal that you can always rely on your attachment and make you feel confident of its quality and longevity. KINSHOFER stands for attachments of highest quality. All our employees and our quality management are committed to this quality every day. We are confident of the quality level we provide and therefore grant a 2-year-standard-warranty. Enjoy working with them and experience and create quality.

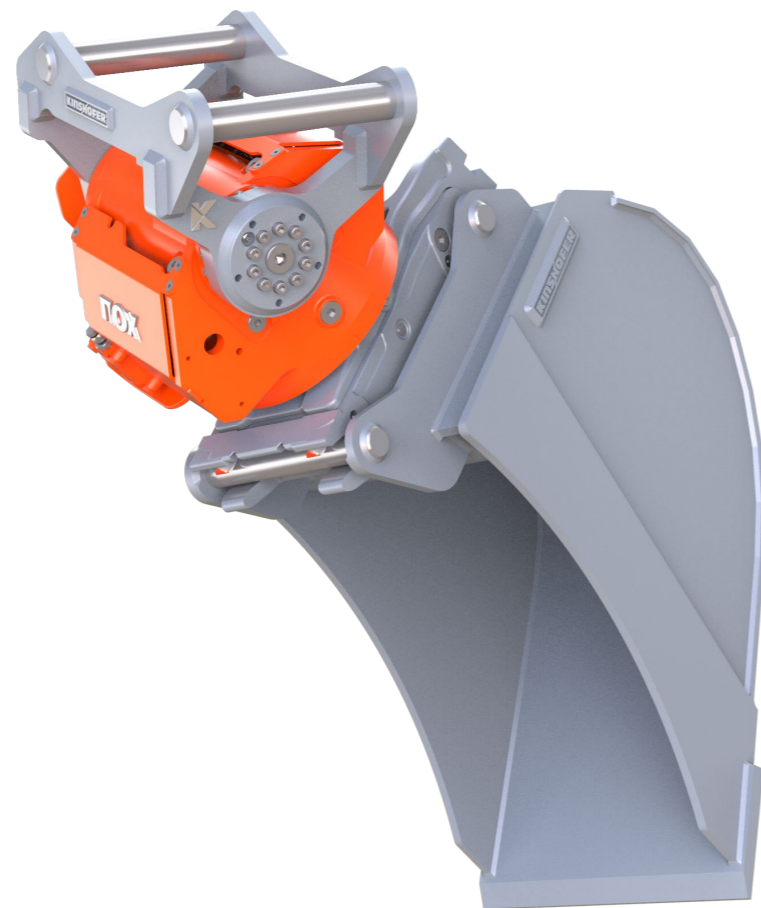

**VISIT OUR WEBSITE:**  
**NOX.KINSHOFER.COM**

## Turn efficiency in your direction!

With using the NOX Tiltrotator, you are not only reducing the need for repositioning your excavator and thus sparing the ground from damage (especially when it comes to landscaping tasks), but you will also speed up your work. The attachments can be positioned within the complete reach of the boom to work around obstacles. Fast and easy levelling works with a levelling bar can be realized without repositioning the excavator. Precise setting of curbstones, dosed and accurate filling of trenches with a bucket turned by 90° as well as the handling of different kinds of materials in narrow areas are no problem with the NOX Tiltrotator.

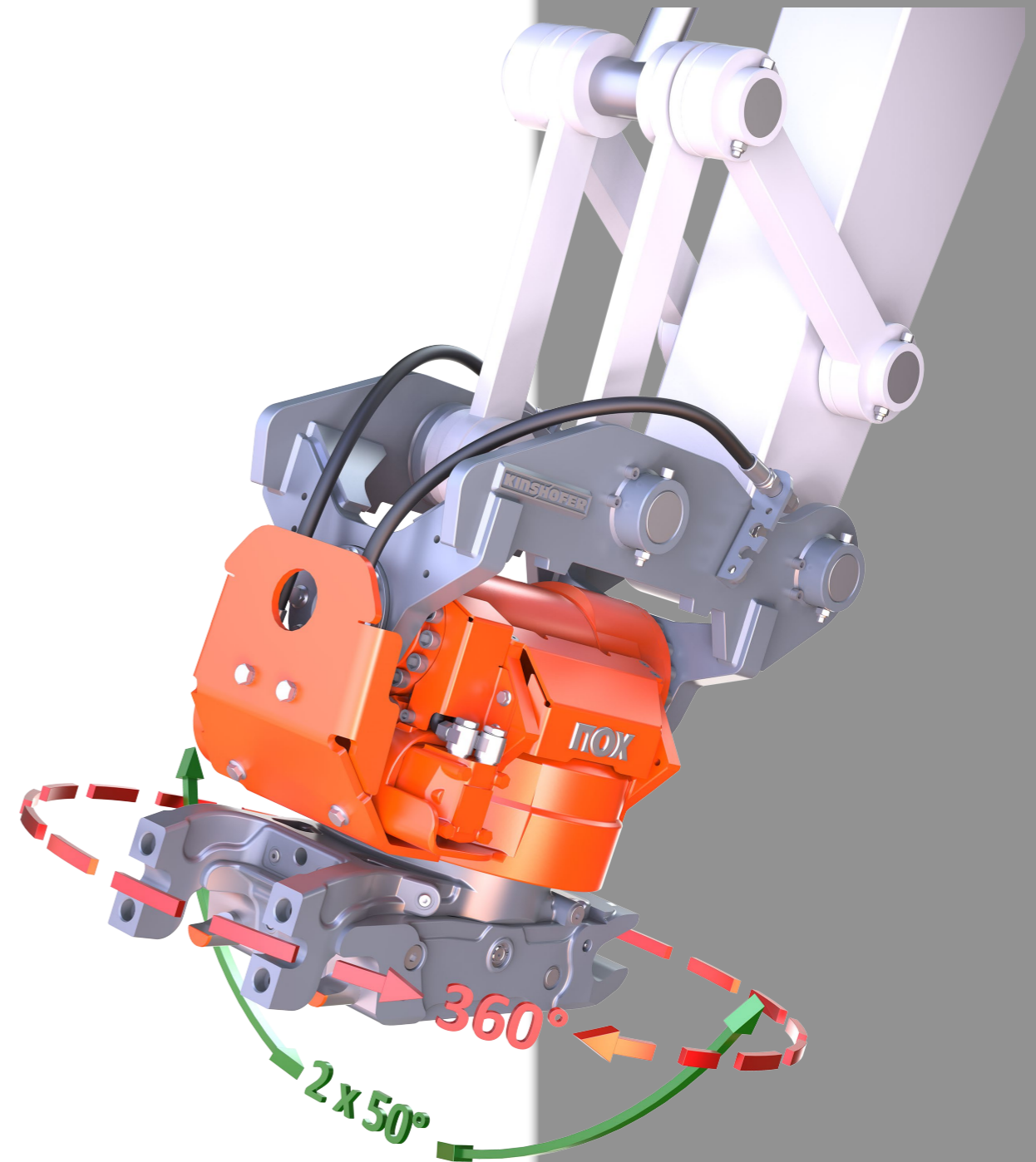



# NOX Tiltrotators

Experience and innovation have led to one of the most advanced tools for excavators: the NOX Tiltrotator. 360° continuous rotation and a tilt angle of 2 x 50° make it a universal joint, allowing for a whole new range of applications. Combined with a quick change system and various attachments this means highest efficiency at any construction site.

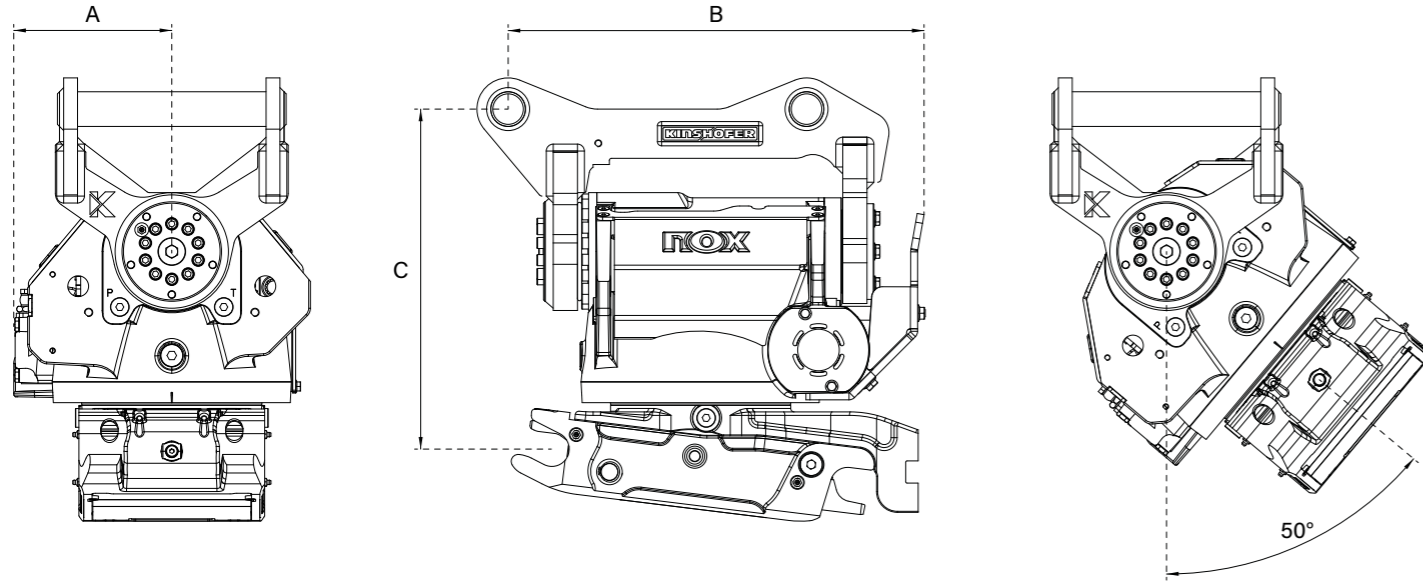

TR06NOX

TR07NOX

TR11NOX

TR14NOX

TR19NOX

TR25NOX

Operating weight	3 - 6t	4 - 7t	6 - 11t	10 - 14t	14 - 19t	19 - 25t
Weight* (from)	180 kg	200 kg	320 kg	485 kg	580 kg	860 kg
Width A* (from)	205	205	215	240	230	260
Length B* (from)	460	460	580	610	645	845
Height C* (from)	365	420	475	565	580	650
Recomm. bucket width max.	1100 mm	1100 mm	1300 mm	1600 mm	1700 mm	2000 mm
Breakout force max. (ISO)	35 kN	50 kN	75 kN	110 kN	150 kN	170 kN
Tilt angle	2 x 50°	2 x 50°	2 x 50°	2 x 50°	2 x 50°	2 x 50°
Tilt torque (constant)	8,5 kNm	10 kNm	16 kNm	26 kNm	34 kNm	44 kNm
Rotation speed	9 per min	8,5 per min	8,5 per min	8,5 per min	8,5 per min	8,5 per min
Rotation torque	4500 Nm	4600 Nm	6400 Nm	7800 Nm	8800 Nm	9300 Nm
Hydraulic pressure max.	25	25	27	30	30	30
Recomm. pump capacity CSP	30-80	30-80	40-100	80-160	100-180	120-200
Recomm. pump capacity DF04/06/10	15 / 32	15 / 32	21 / 40	40 / 45	60 / 50	70 / 70
Electric swivel	-	optional	optional	optional	optional	optional

\*Specifications depend on the machine configuration (upper bracket and lower quick coupler)



# NOX Powerful

TILTROTATOR WITH CYLINDERS

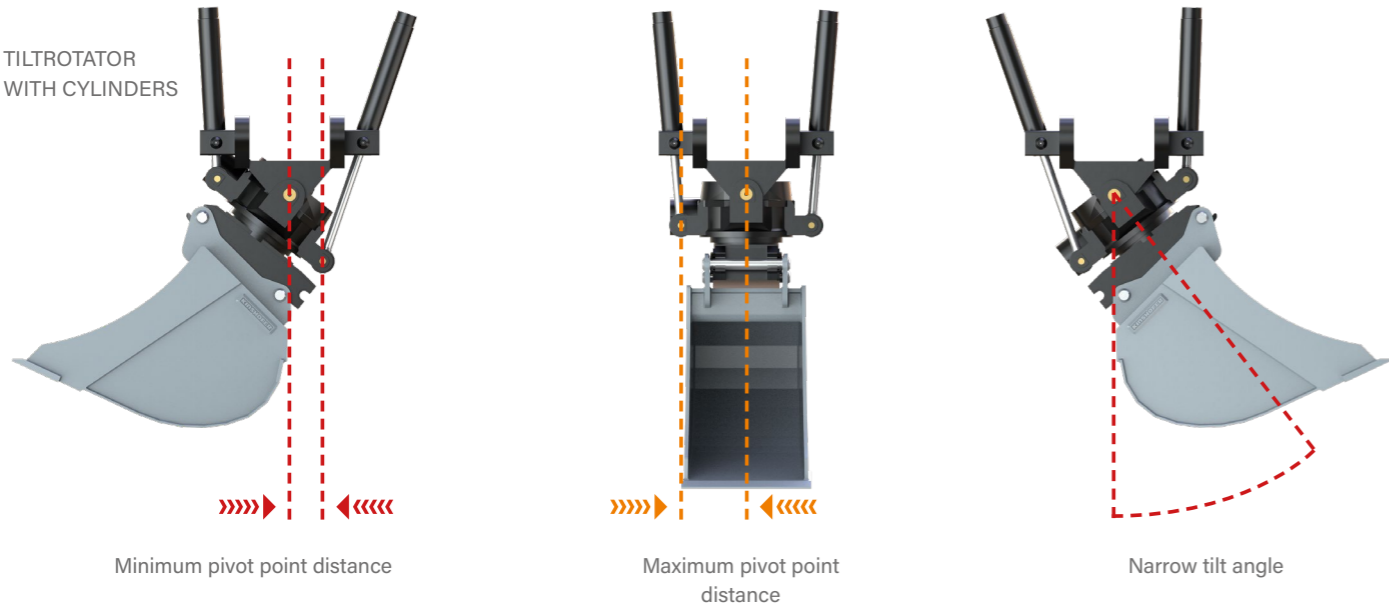

NOX TILTROTATOR CYLINDERLESS

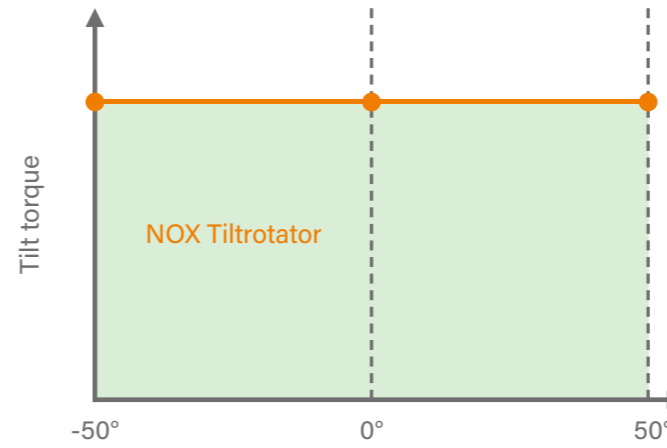
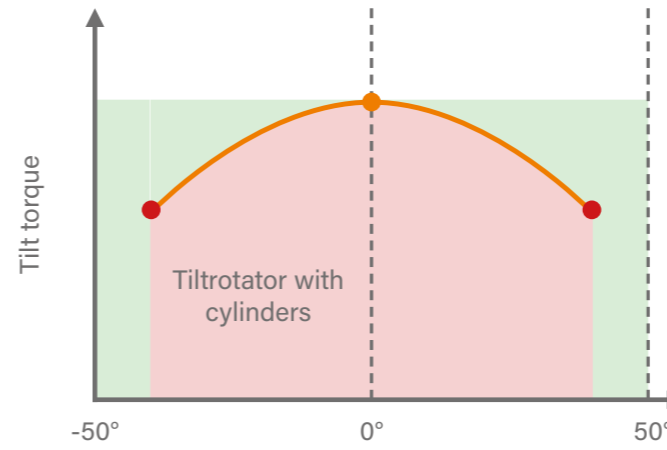
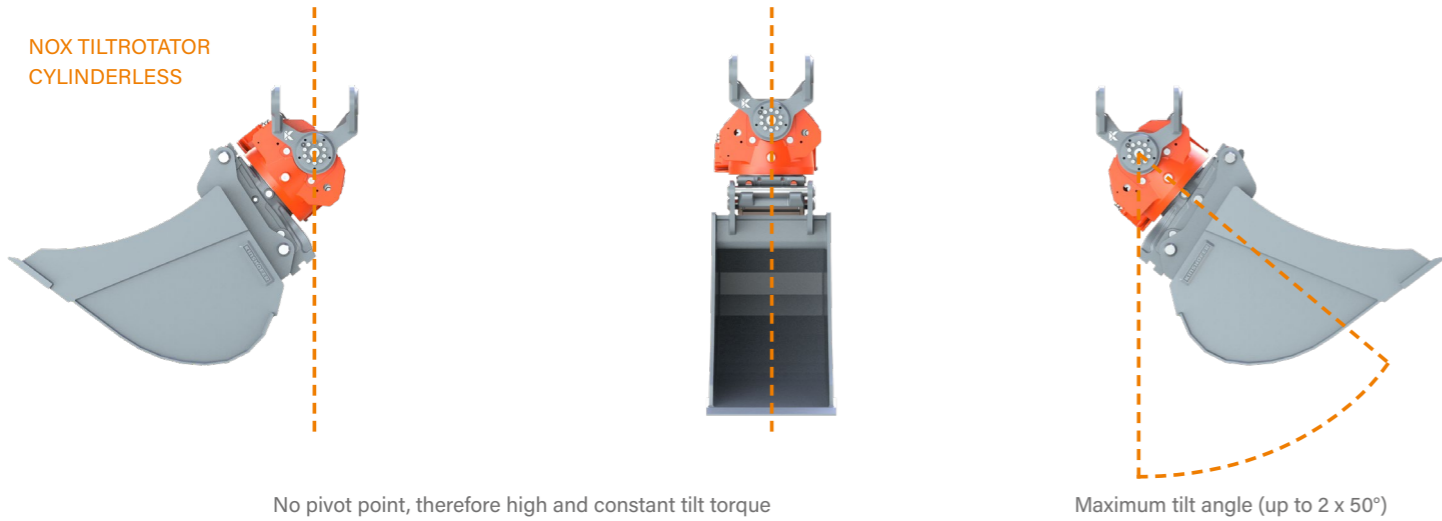

## NOX Tilt torque

The cylinderless, extremely flat drive provides for a very low height as well as a narrow width. An elliptic piston generates a high and constant tilt torque thanks to its single gearing. The robust cast housing features a high stability due to a special material alloy, guaranteeing a long life even under the toughest conditions. The extremely rugged and strong drive for difficult tasks has a proper greasing and is thus low-maintenance.

## NOX Tilt angle

360° continuous rotation and 2 x 50° tilt angle turn your machine into a multifunctional allrounder, increasing the flexibility and efficiency of all your attachments.

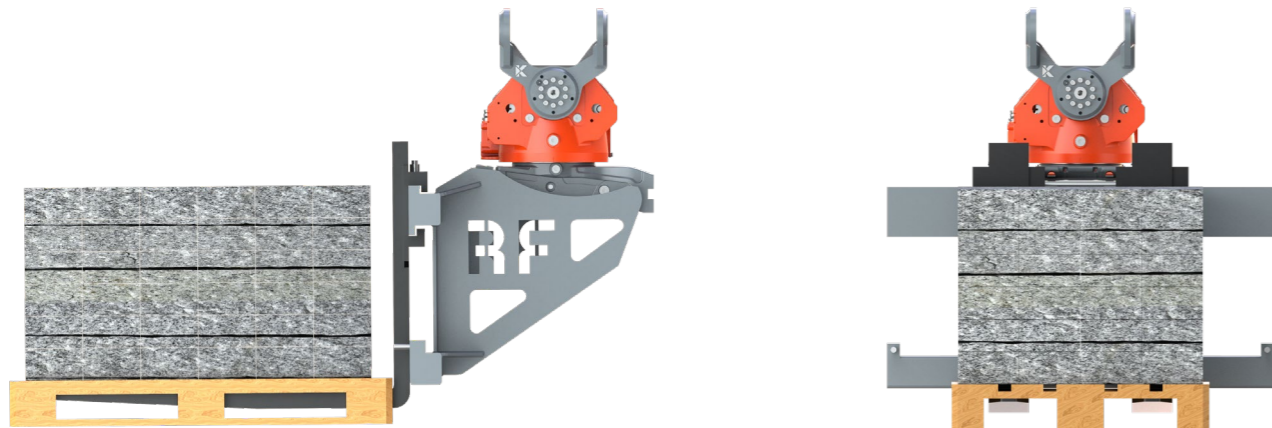

Pilot check valve ensures a high holding torque

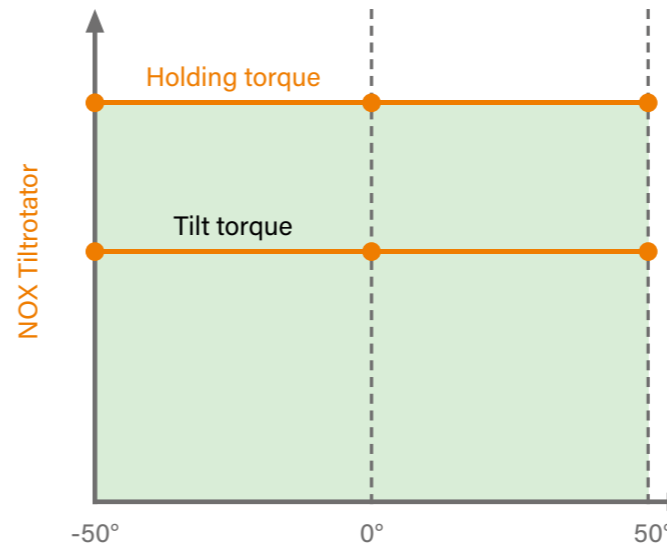

## NOX Holding torque

The NOX Tiltrotators are equipped with counter-balance valves, providing firm load holding in the desired position.

# NOX Tiltrotator

## SYSTEM: UPPER BRACKET & LOWER QUICK COUPLER

The Tiltrotator can be mounted directly to the excavator arm (direct mount) or it can be "Sandwich" mounted to the excavator by a quick coupler. Preferably, the excavator coupler is the same as the lower quick coupler on the NOX Tiltrotator, but it is not necessarily required. The Tiltrotator can thus be uncoupled and coupled again in no time. The lower quick coupler allows for a safe and fast exchange between attachments. Switching fully hydraulically between hydraulic attachments is no problem with the SmartFlow coupler system.

## DESIGN: SELF-CONTAINED UNIT

The compact design with its fully integrated tilt and rotation unit provides highest safety against damage. There are no protruding cylinders or piston rods that can be damaged, increasing the reliability of the NOX. In addition, the low design maintains higher breakout forces of the machine.

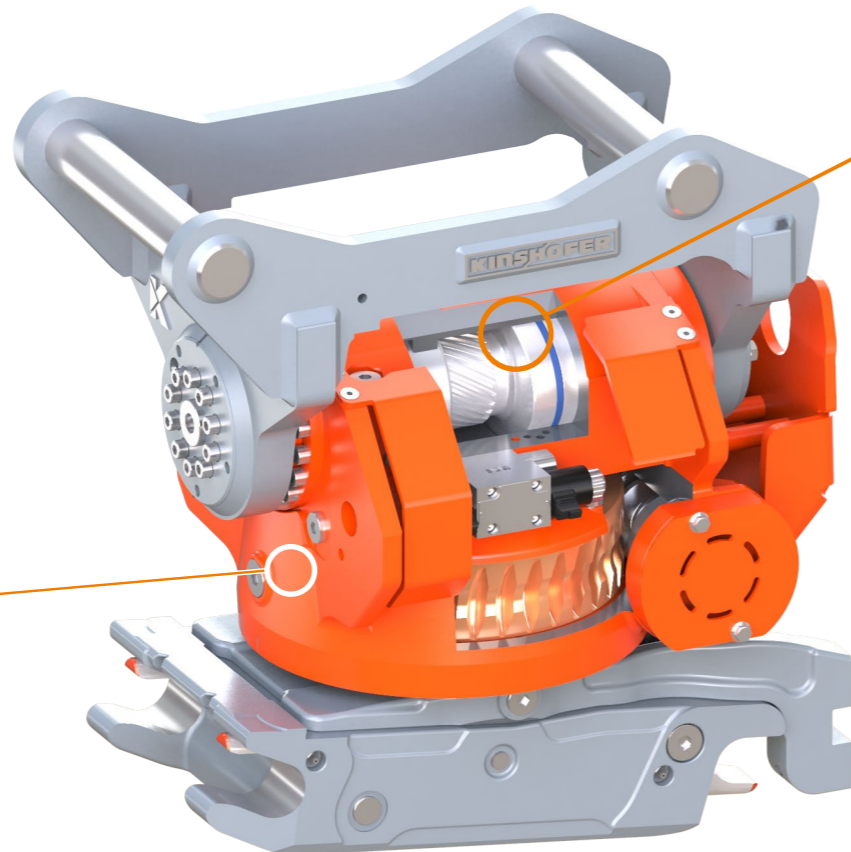

## SET-UP: COMPACT DESIGN

The cylinderless, extremely low and narrow built drive unit allows for very narrow bucket width, that are usually not wider than the excavator boom. Therefore, digging down in deep trenches becomes possible and very easy.

## SAFETY: SAFE WORKING AREA



The increased working radius reduces the need for repositioning your excavator to a minimum. Manual works such as manual digging in the danger zone by a co-worker are not necessary, as these works can be managed from the excavator cabin with the NOX Tiltrotator. The S-Lock quick coupler with front-lock prevents the attachments from falling down unintendedly.

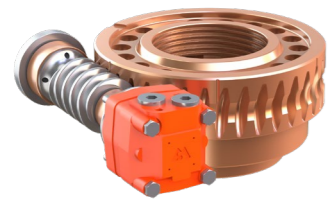

## WORM DRIVE

The oversized worm gear absorbs shock loads with ease. The compact diameter and yet high torque ensures a very slim design, hence keeps the overall width of the NOX extremely small.



## HOUSING

The robust cast housing features a high stability due to a special material alloy, guaranteeing a long life even under the toughest conditions. The integrated motor cover protects the hydraulic motor of the worm drive from damage from below. The quality of our precision components is ensured by 3D coordinate measuring machines with tactile and optical measuring sensors.

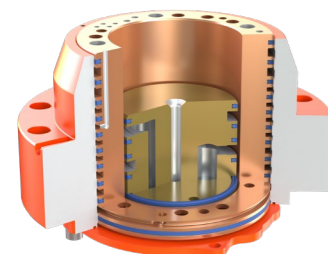

## HIGH-FLOW SWIVEL

The optional high-flow swivel provides industry leading flows for attachments that require more flow to operate properly. As an option, an electric rotary unit for quick coupler sensors and attachments with switch valve (mainly in railway construction) can be used.

## INTEGRATED GRIPPER TRG

With the integrated gripper you get an additional attachment for handling poles, tubes and curb stones.

The gripper is integrated at the lower quick coupler and does not affect the height or the attachment cross-movement.

## RAILROAD GRIPPER RR-TRG

The RR-TRG gripper has been designed especially for heavy duty tasks, such as gripping railroad sleepers or rails. The extremely strong gripper module has been constructed for efficient gripping at a 40° angle. The gripper unit can be removed quickly and easily.



# NOX Benefits

## FLEXIBLE OPERATION

Fast and uncomplicated response to requirements to be more competitive.

## HIGHER SAFETY

Manual works within the danger area are reduced to a minimum.

## LESS WEAR

The compact and extremely robust design without hydraulic cylinders lowers the risk of damages.

## HIGHER EFFICIENCY

Working more efficiently saves consumables and labor costs and reduces the required working times. The tasks can thus be finished faster and the wear is kept to a minimum.

# Optional accessories



TRG gripper

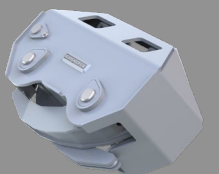

RR-TRG gripper



Type	Opening	Closing time	Closing force	Capacity
TRG07	415 mm	1,5 sec.	7,5 kN	300 kg
TRG11	610 mm	1,3 sec.	10 kN	500 kg
TRG19	713 mm	1,7 sec.	18 kN	900 kg
TRG25	1100 mm	2,0 sec.	19,5 kN	1400 kg
RR-TRG	822 mm	3,9 sec.	30,1 kN	5000 kg

The RR-TRG gripper is only available for TR19NOX and TR25NOX.



## MOUNTING TO EXCAVATOR ARM EXCAVATOR BOOM

When mounting the NOX Tiltrotator directly to the excavator dipper, the tiltrotator can use its maximum force. The "Sandwich" mounted Tiltrotator features a quick coupling adapter at the top to accept pick up by the machine coupler.

## DIRECT MOUNT

- > Lower height
- > Higher force transmission



## "SANDWICH"-STYLE MOUNT

- > Can be used with different excavators of the same class
- > Can be uncoupled to use attachments that do not require a Tiltrotator



## Functional exchange, depending on demands!

As a global company we know that customers of different regions become familiar with certain styles and characteristics of products, including quick couplers.

We constantly improve our designs for higher productivity and greater safety and we also understand that customers may already own existing products which require a compatible coupler solution to keep on using them. We are generally differentiating between three different quick coupler systems:

### KINSHOFER QUICK COUPLER SYSTEMS:

#### FULLY HYDRAULIC QUICK COUPLERS

Fully hydraulic quick couplers connect the worktool mechanically as well as hydraulically without leaving the cabin. No need to connect hoses anymore. KINSHOFER provides its NOX Tiltrotators either with the well-known dedicated OilQuick system or with its own fully hydraulic system SmartFlow for pin-to-pin quick couplers.

#### HYDRAULIC QUICK COUPLERS

The hydraulic quick coupler allows for an efficient and safe mounting of the attachment without leaving the cabin. The spring-pretensioned locking pins provide for a force-fit connection without play. Besides the special spring-locking system, the carrier pin (system S-Lock) is also secured mechanically. The attachment cannot get loose.

#### MECHANIC QUICK COUPLERS

An automatic spring-locking system facilitates the coupling of the tool. By simply turning a socket, the coupler is opened or closed for the tool exchange. This provides a high functional safety; the spring loaded system is over-center locking. Besides the special spring-locking system, the carrier pin is also secured mechanically.



FULLY HYDRAULIC QUICK COUPLER SYSTEM



HYDRAULIC QUICK COUPLER SYSTEM



MECHANIC QUICK COUPLER SYSTEM

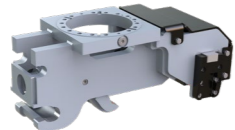

KINSHOFER SMARTFLOW  
D-LOCK & X-LOCK

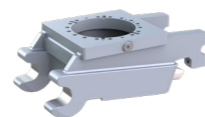

SYSTEM L-LOCK

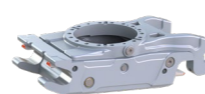

SYSTEM S-LOCK

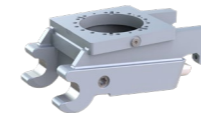

SYSTEM L-LOCK

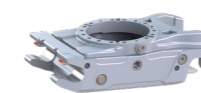

SYSTEM S-LOCK

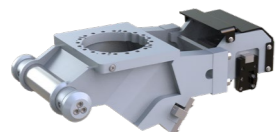

KINSHOFER SMARTFLOW  
T620



SYSTEM D-LOCK



SYSTEM X-LOCK

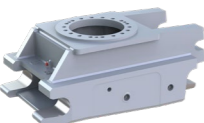

OILQUICK

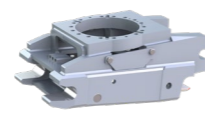

SYSTEM OILQUICK

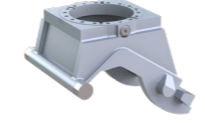

SYSTEM VERACHTTERT

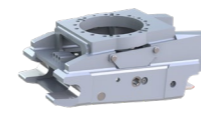

SYSTEM OILQUICK

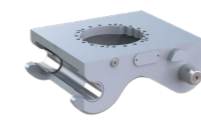

SYSTEM LIEBHERR

**FUNCTION:**  
MULTIFUNCTIONAL COUPLING SYSTEM

The hydraulic valve bank [1] can be easily fitted to any quick coupler and ensures a safe and efficient connection between the hydraulic circuits without manual assistance. The excavator turns into a multifunctional tool carrier.

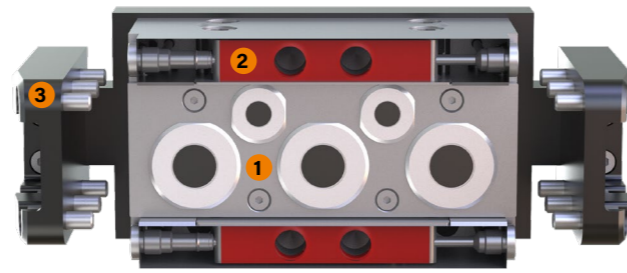

**DESIGN:**  
FLEXIBLE BLOCK SUSPENSION

Due to the flexible suspension of the hydraulic blocks, wear and tear as well as tolerances within the quick coupler can easily be compensated.



**LOCKING:**  
SAFE LOCKING MECHANISM

The valve blocks at the quick coupler and the attachment are securely locked by an internal and independent locking system [2]. Therefore, the blocks can be mounted in a flexible way. The robust guides [3] enable the hydraulic couplings to couple drip-free even with the quick coupler connected on an arched path.

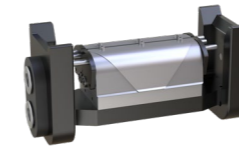

**SAFETY:**  
DIRT PROTECTION ON THE ATTACHMENT SIDE



The hydraulic valves and the valve block at the attachment side are protected from dirt and damage by the cover flaps. The hydraulic valves can be coupled under pressure without the need for depressurization.

## Fully hydraulic coupling system SmartFlow

Type	Tonnage
Size S (150 l/min)	6 - 13t
Size M (250 l/min)	14 - 23t
Size L (420 l/min)	24 - 40t

**FUNCTION:**  
2 HYDRAULIC COUPLINGS

2 couplings are required for the main functions of for example a hydraulic pallet fork.

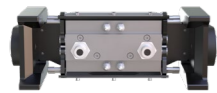

**FUNCTION:**  
3 HYDRAULIC COUPLINGS

2 couplings are required for the main functions and one drain line for the overflow oil line of for example a drum cutter.



**FUNCTION:**  
3 HYDRAULIC COUPLINGS

2 couplings are required for the main functions and one drain line for the overflow oil line of for example a hydraulic compactor.

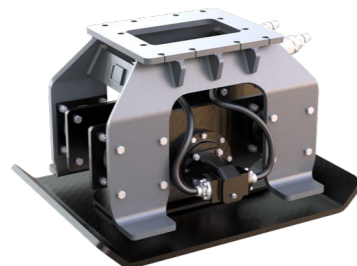

**FUNCTION:**  
2 HYDRAULIC COUPLINGS

2 couplings are required for the main functions of for example a clamshell bucket.



## Fully compatible SmartFlow

The fully hydraulic quick coupler system SmartFlow turns the exchange of attachments into a very easy, safe and fast operation.

The operator changes the hydraulic attachment and couples the hydraulic connections by simply pushing a button in the driver's cabin. Due to the separate locking of the valve blocks, there are no forces transferred to the quick coupler, guaranteeing durability.



# NOX Control

## NOXProp+ & NOXProp CSP - CONTROL SYSTEM

Although this control system only requires one hydraulic function from the excavator, all Tiltrotator functions can be used at the same time. Also functions like steering/driving control, boom swing and dozer blade etc. can be controlled optionally. All functions are controlled proportionally and a separate control system is installed at the excavator. The joysticks of the machine will be replaced by new joysticks provided by KINSHOFER.

### KEY FEATURES NOXProp+

- ▷ Optimal NOX performance thanks to perfectly adjusted control
- ▷ Bright and high-definition touchscreen
- ▷ Autocalibration
- ▷ Position indicator at the display
- ▷ 4 different user profiles with up to 10 tool profiles (more flexibility)
- ▷ CAN Bus system
- ▷ All main settings can be adjusted directly on the touchscreen, no laptop/smartphone necessary
- ▷ Direct mode: When the NOX is disconnected, it is possible to control the original AUX lines in both directions
- ▷ Connectivity (WiFi, LTE, GPS, Bluetooth)
- ▷ Remote maintenance
- ▷ Easy installation
- ▷ Integration with 2D/3D excavation system - NOXGeo
- ▷ Optional steering/driving control
- ▷ BIM-ready
- ▷ SmartTag- interface to fleet management



NOXProp+ TOUCHSCREEN

### MACHINE REQUIREMENTS FOR CSP - NOXProp+ & NOXProp

- ▷ Single-acting hydraulic circuit (hammer line)
- ▷ Pressure line
- ▷ Tank line (free return directly to tank)



NOXProp CONTROL UNIT

### KEY FEATURES NOXProp

- ▷ All functions can be controlled proportionally
- ▷ All parameters can be adjusted individually with laptop
- ▷ 4 different user profiles with up to 10 tool profiles (more flexibility)
- ▷ Direct mode: When the NOX is disconnected, it is possible to control the original AUX lines in both directions.



BG-MODULE CONNECTOR

### TOUCHSCREEN: ERGONOMIC CONTROL UNIT

- ▷ Highly bright display - legible even at direct sunlight
- ▷ Easy switch between different profiles
- ▷ Locking/unlocking of quick coupler
- ▷ Sensor control of the quick coupler
- ▷ Tool profile settings
- ▷ Adjustment of single function speed
- ▷ Reliable ram mount

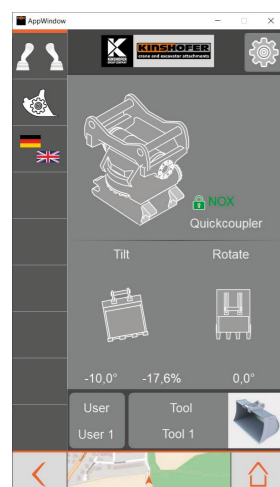

Home display attachment & quick coupler

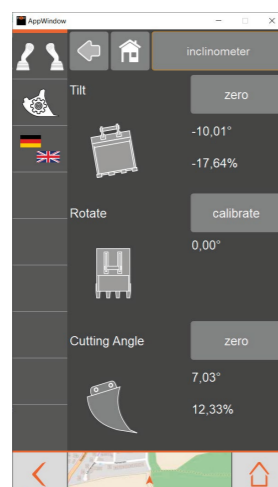

Geometry overview of attachment and interface to 2D/3D systems

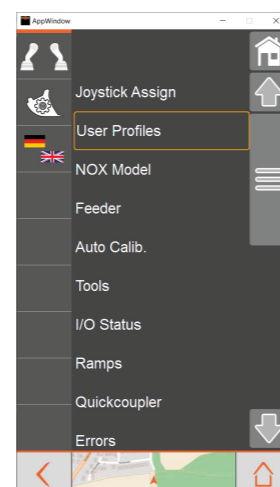

Easy and logical menu navigation

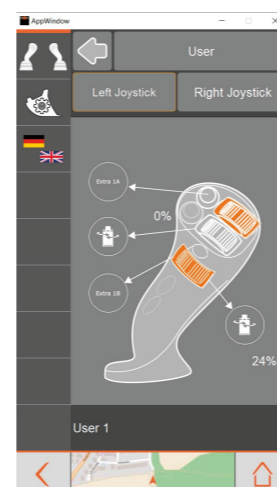

Individual function configuration of joystick buttons



STANDARD JOYSTICK FRONT



STANDARD JOYSTICK BACK

## Joysticks

The L8 is the multifunctional ergonomic joystick grip that has set a new standard with its innovative, functional design. You can control two roller functions simultaneously with your thumb and index finger. Up to three rollers can be installed, two for the thumb and one for the index finger. On the grip there is room for up to nine buttons, meaning that most functions can be gathered in a small area. (Joysticks must be replaced when CSP - NOXProp+ or NOXProp is installed.)

### OPTIONALLY EXTENDABLE:



F-N-R JOYSTICK OPTION

ADDITIONAL PROP JOYSTICK OPTION

ADDITIONAL PROP & F-N-R JOYSTICK OPTION



## DF04 CONTROL SYSTEM

The DF04 control system requires 2 double-acting hydraulic circuits. Only two functions, e.g. rotation and tilting, can be realized simultaneously. In order to control the attachment or the quick coupler, one of the two hydraulic circuits is separated by a switch valve, installed on the NOX Tiltrotator. Therefore, up to two extra functions, e.g. quick coupler, can be realized.

### MACHINE REQUIREMENTS FOR DF04

- ▶ Hydraulic rotation circuit to control the NOX rotation
- ▶ Hydraulic circuit with high flow controls tilt, additional functions and quick coupler
- ▶ Control system to switch between tilt, additional functions and quick coupler
- ▶ One free ON/OFF button at existing joysticks to control the switch between the different functions



DF04-CONTROL UNIT

## DF06 CONTROL SYSTEM

The DF06 control system requires 2 double-acting hydraulic circuits for the rotation and tilt movement of the NOX Tiltrotator. For the use of a hydraulic quick coupler, an additional circuit is required. The tilt function can be switched by pressing a button on the joystick to the extra function controlling e.g. the opening and closing of a grab.

### MACHINE REQUIREMENTS FOR DF06

- ▶ Hydraulic rotation circuit to control the NOX rotation
- ▶ Hydraulic circuit with high flow controls tilt and extra function, e.g. grab
- ▶ Control system to switch between tilt and extra function
- ▶ One free ON/OFF button at existing joysticks to control the switch between tilt and extra function
- ▶ Original joysticks remain
- ▶ No additional control required - all hydraulic circuits on the excavator
- ▶ Each function needs a double-acting hydraulic circuit

## DF10 DIRECT FEED SYSTEM

The DF10 control system requires at least 2 double-acting hydraulic circuits for the rotation and tilt movement of the NOX Tiltrotator. Including the lines of the quick coupler function, two other hydraulic circuits, e.g. open/close grab and open/close integrated gripper, can be connected to the NOX Tiltrotator. Furthermore, an additional drain line can be installed.

### MACHINE REQUIREMENTS FOR DF10

- ▶ For complete control of the NOX, 4 double-acting hydraulic circuits are required: rotation, tilt, extra function 1 and extra function 2 (gripper), one quick coupler circuit
- ▶ Special solution: division of one hydraulic circuit with a switch valve, so two different functions can be controlled by one control circuit. The switch valve has to be installed at an adequate place at the carrier machine or the NOX
- ▶ No additional control required - all hydraulic circuits on the excavator
- ▶ Original joysticks remain
- ▶ No valves or cables on the NOX required
- ▶ Each function needs a double-acting hydraulic circuit
- ▶ Minimal configuration: 2 hydraulic circuits (tilt and rotation) when mechanical quick coupler and no hydraulic attachment

# DF04, DF06 & DF10 Control systems

	NOXProp+	NOXProp	DF04	DF06	DF10
NOXGeo (GPS-ready)	✓	●	●	●	●
Autocalibration	✓	⊖	⊖	⊖	⊖
Angle position indication	✓	⊖	⊖	⊖	⊖
Individual operator settings	✓	✓	⊖	⊖	⊖
Individual speed setting	✓	✓	⊖	⊖	⊖
Touchscreen in cabin	✓	⊖	⊖	⊖	⊖
Trouble shooting on display	✓	⊖	⊖	⊖	⊖
Remote maintenance	✓	⊖	⊖	⊖	⊖
Connectivity tools (Bluetooth, LTE, WiFi)	✓	⊖	⊖	⊖	⊖
Fully proportional control	✓	✓	depending on machine	depending on machine	depending on machine
Changing roller position	✓	✓	⊖	⊖	⊖
Individual tool settings	✓	✓	⊖	⊖	⊖
Tilt, rotation & extra in same movement	✓	✓	⊖	⊖	depending on machine
High flow attachment	●	●	⊖	⊖	●
Quick coupler safety sensors	●	⊖	⊖	⊖	⊖
Quick coupler control	✓	⊖	⊖	⊖	⊖
Driving/steering function	●	⊖	⊖	⊖	⊖
Fleet management	●	●	●	●	●
Machine assistance systems	●	⊖	⊖	⊖	⊖

✓ Standard

● Optional



## Always the right control system depending on the machine's hydraulic configuration

The table provides a quick overview on the different functions and for which control system they are available. Short summary on machine requirements:

CSP: NOXProp+ & NOXProp  
Hammer/shear circuit

DF04  
2 x proportional double-acting circuits

DF06  
2 x proportional double-acting circuits (tilt and rotation)  
1 x hydraulic quick coupler circuit

DF10  
2 x proportional double-acting circuits (tilt and rotation)  
1 x hydraulic quick coupler circuit  
1 x double-acting high pressure circuit (compactor)  
1 x double-acting low pressure circuit (gripper)

# NOX Sensors

## NOXGeo SENSOR TECHNOLOGY

With the NOXGeo, sensors send position data to the digital control at the NOXprop+ touchscreen in the driver's cabin. Thereby, the attachments are connected to the digital technology of the excavator/machine control. The NOXGeo system also allows the functionality to interface with 2D/3D systems of all common manufacturers thanks to the open system.



## GPS INTEGRATION OF 2D/3D SYSTEMS

It is possible to integrate various makes of GPS into the NOX control system. Thanks to the GPS you can use the excavator to collect and define points. Connect the computer of the machine via the integrated GSM-modem to get fast support and transfer data. With our 3D-system you can take the last step towards machine control.



## TILT SENSOR TILT MOVEMENT



The exact position of the tiltrotator's tilt movement and the attachment is transferred directly to the control display in the driver's cabin by means of the tilt sensor.

## ROTATION SENSOR ROTATION MOVEMENT



The KINSHOFER rotation sensor shows the exact position of the tiltrotator and the attachment during rotation. The determined data is transferred directly to the control display in the driver's cabin.

## SYSTEM: SMARTTAG

The SmartTag is a microcontrol-based tool with a communication functionality via mobile radio and an internal storage to locally back up operating information, error information, etc. The unit only measures 15 cm, it is waterproof, shock resistant, thermo-stable from -25 up to 80 °C, shockproof and has an internal energy supply for approx. 2 years.

## NETWORKING: DATA EXCHANGE

The tool management system consists of a SmartTag at the attachment as well as its interconnection with the terminal and/or cloud. The SmartTag measures vibrations and positions of the attachment. This information is directly transferred to the cloud via LTE and is thus independent from the machine. From there, the data can be read with every terminal device. The way, frequency and send release of the data exchange can be set individually.

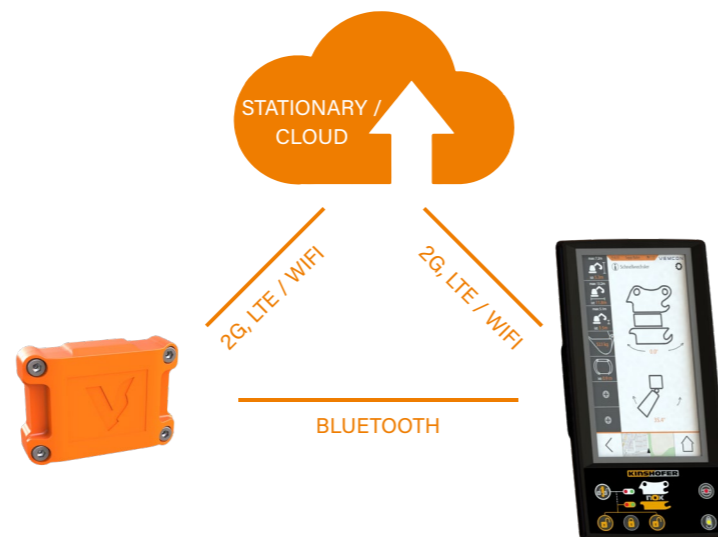
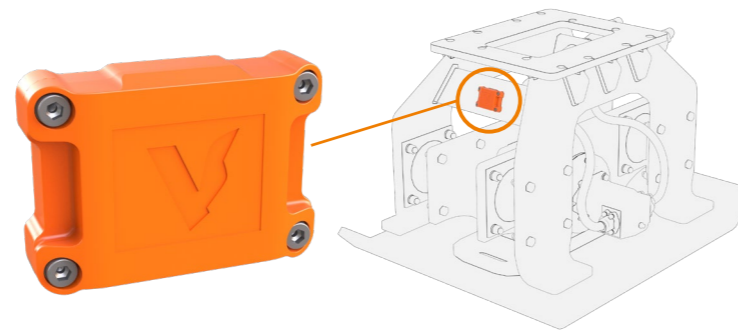

## SMARTTAG FUNCTIONS

**GPS-TRACKING**  
The function GPS-tracking is used to detect the location of an attachment by entitled persons.

**DIGITAL TYPE PLATE**  
The digital type plate provides the identical data as does the mechanical type plate like serial number, name and weight, as well as operating pressure.

**PREVENTIVE MAINTENANCE**  
This function is used for issuing a service recommendation in which a preventive service for the respective attachment will be recommended in order to prevent downtimes.

**REMOTE SERVICING / LIVE CONNECTION**  
Here, an energy-saving near field connection is generated. The touchscreen is used as transmission medium to the remote servicing computer.

**THEFT PROTECTION**  
This function shall be used to allocate an attachment to a certain area of action and alert the owner when the attachment is removed from that area without permission.

**WORKING HOURS**  
Especially important for rental companies - working hours can be recorded and reported.

# NOXGeo Sensor technology

By means of the sensors, the manual staking out of the work area by a person is reduced, as the precise dimensioning is shown on the display in the driver's cabin. The controlled and exact excavation of the required amount results in large time savings and reduced fuel consumption. Furthermore, the attachments and the carrier wear less.

KINSHOFER equips the NOX Tiltrotator with the rotation sensor, the tilt sensor comes from the 2D/3D system provider. In combination with certain excavator systems and makes, the NOXGeo system allows for an auto-turning function.

# SmartTag Tool tracker

The SmartTag and the cloud-based tool management support the driver and operator with the efficient choice and detection of suitable tools for each special task. Operators have their complete fleet under control and thus avoid downtimes and maximize their tool workload.

The SmartTag combines two up to now separated functions in one sensor: tool detection and tracking. As digital type plate, the tool tracker files information on geometries, name, manufacturer, year, ID and operation (e.g. required operating pressure of attachment). At the same time, it gathers, analyzes and detects operating hours, cycles and work processes. Thank to GPS position and timestamp, you receive data like when and where an attachment had been put down and how it had been used.



# NOX Attachments

## LANDSCAPING

The NOX Tiltrotator provides a third dimension, resulting in a reduced need to reposition your carrier machine. Ground damages and subsequent recultivation works are minimized. When laying out a garden or protecting slopes from erosion, the functionality of the NOX strongly shortens the construction time.



## GENERAL CONSTRUCTION

Excavation or filling works can be realized precisely thanks to the NOX Tiltrotator with its tilt and turn function. The work can be done within the reach of the excavator arm without repositioning the carrier machine in a faster and more profitable way. The working safety on site is also increased when handling construction material.



## RAIL CONSTRUCTION

Thanks to the NOX Tiltrotator, a lot of works that are difficult or impossible in rail construction due to the limited lateral mobility of the carrier machine can be realized. Works under already existing rails or at slopes as well as the exact positioning of sleepers are possible without repositioning the excavator thanks to the tilt and turn function.



## ROAD CONSTRUCTION

When constructing roads, time is a crucial factor, but also precision and safety when e.g. levelling grounds, working at embankments or excavating soil. Thanks to the tilt and turn function of the NOX Tiltrotator, all works can be managed safely from the driver's cabin and less manpower is required in the danger area.



## CABLE DUCT WORKS

The NOX Tiltrotator enables precise working under, in between or close to already existing cables. By tilting and turning the attachment in the required position, you can reduce manual cable duct works.

When maintaining existing cable ducts or installing new ones, works can be realized much more effectively and after all more safely.



## MATERIAL HANDLING

Precise handling of e.g. palletized curbstones is no problem with the NOX Tiltrotator. The high and constant holding torque allows for a safe holding of loads. When operating in narrow areas, loads can be held e.g. around scaffolding or lifted over a fence.



## SEWAGE WORKS

Working in sewer systems is characterized by little space and narrow areas. With a NOX Tiltrotator you can easily dig around gully wells or excavate from the required angle without repositioning the excavator. The endless rotation and the 50° tilt angle to both sides allows for the exact positioning of the attachment.

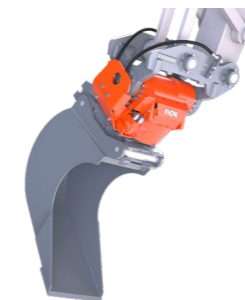

## DEMOLITION

The immediate separation of debris at the demolition site saves a lot of time and recycling costs. Some building materials have to be disposed separately and with the NOX Tiltrotator you can separate those precisely from the other materials. After loading the material, the construction site can be cleared with e.g. a brush mounted to the NOX.



# NOX Large variety of KINSHOFER attachments

## 4-Grip

Easy mounting - easy handling of your tasks: that is our new 4-Grip for our demolition and sorting grabs of the D-series up to 9t operating weight as well as our multi purpose grabs of the A-series up to 9t. The device is easily bolt onto the shells and you can grab concrete units, curbstones etc. smoothly.

Thanks to its special kinematics you can grab items not only when closing the shells but also when opening. Shaft rings can be loaded and unloaded fast and easy without damaging them!

- ▷ **Economic solution**, as it is only an accessory that increases the flexibility of your attachment
- ▷ **Robust design**
- ▷ **Plastic compression rolls** avoid damage of the material to be gripped
- ▷ **Fast and easy mounting and removal** on site
- ▷ **Low additional weight:** only 28 kg in total
- ▷ **High load capacity** of 750 kg

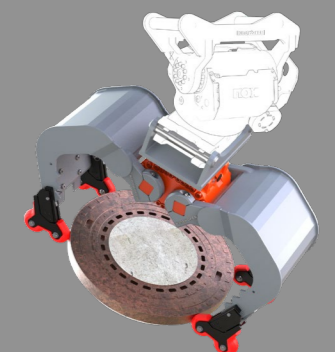

Bucket sets KIT (SKP/SKD/SKK)

Type	Bucket types	Width (SKP/SKD/SKK) (mm)	Volume (SKP/SKD/SKK) (liter)	Weight (SKP/SKD/SKK) (kg)	Operating weight (t)
KIT 3-S40	SKP 4 / SKD 4 / SKK 4	1100 / 620 / 300	160 / 120 / 60	110 / 80 / 50	<3
KIT 4-S40	SKP 4 / SKD 4 / SKK 4	1200 / 620 / 300	200 / 160 / 60	120 / 80 / 50	<4
KIT 6-S40	SKP 6 / SKD 6 / SKK 6	1300 / 720 / 300	300 / 280 / 160	130 / 140 / 75	<6
KIT 6-S45	SKP 6 / SKD 8 / SKK 10	1300 / 720 / 300	300 / 280 / 160	130 / 140 / 75	<6

Package consists of: grading bucket, backhoe bucket with teeth, cable bucket, adapters system S-Lock

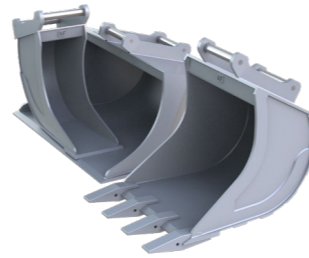

Levelling bars with roller

Type	Width (mm)	Weight (kg)	Operating weight (t)
AVB 8-1800	1800	200	<8
AVB 8-2100	2100	300	<8
AVB 8-2200	2200	420	<8

Package consists of: levelling bar with roller, adapter system S-Lock



Fork tines

Type	Tine adjustment	Load capacity max. (mm)	Width (mm)	Weight (kg)	Operating weight (t)
GAF6	mechanical	1900	1000	140	3 - 6
GAH6	hydraulically	1900	1000	160	3 - 6
GAF8	mechanical	1900	1200	190	6 - 8
GAH8	hydraulically	1900	1200	210	6 - 8

Package consists of: fork tines, frame with adapter for system S-Lock



Compactors

Type	Compactor plate (mm)	Compacting force (t)	Frequency (U/min)	Weight w/o adapter (kg)	Operating weight (t)
KHC08	730 x 318	1,5 - 2,5	2500	225	4 - 8

Package consists of: compactor, adapter system S-Lock

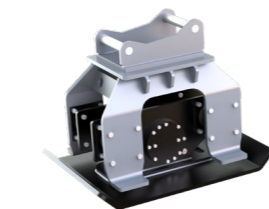

Drum cutters

Type	Torque (Nm @ 350bar)	Cutting force (N)	Nominal power (kW)	Weight Drum cutter (ca. kg)	Operating weight (t)
KDC04-Excavating	2330	13320	18	250	2 - 4
KDC04-Demolition	2330	13320	18	250	2 - 4
KDC04-Profiling	2330	20260	18	250	2 - 4
KDC06-Excavating	2800	16000	18	250	4 - 6
KDC06-Demolition	2800	16000	18	250	4 - 6
KDC06-Profiling	2800	24350	18	250	4 - 6
KDC08-Excavating	3900	22290	22	250	5 - 8
KDC08-Demolition	3900	22290	22	250	5 - 8
KDC08-Profiling	3900	33920	22	250	5 - 8

Package consists of: drum cutter, standard pics, hose set incl. pretension valve in return line



Demolition and sorting grabs with HPXdrive or hydraulic cylinder

Type	Width (mm)	Opening (mm)	Volume (liter)	Weight (kg)	Operating weight (t)	Load capacity form locking (kg)	Closing force (kN)
D05TR-40 HPX	400	1045	75	240	3 - 6	1500	18
D05TR-40	400	1212	60	160	3 - 6	1500	21,5
D07TR-45 HPX	450	1350	150	310	5 - 8	2000	18
D07TR-45	450	1345	90	180	5 - 8	2000	21

Package consists of: demolition and sorting grab (hydraulic block incl. hosing for HPX)

Available as an option: 4-Grip

Multi purpose grabs with HPXdrive or hydraulic cylinder

Type	Width (mm)	Opening (mm)	Volume (liter)	Weight (kg)	Operating weight (t)	Load capacity form locking (kg)	Closing force (kN)
A05TR-40 HPX	400	1043	75	240	3 - 6	1500	18
A05TR-40	400	1233	60	160	3 - 6	1500	21,5
A07TR-45 HPX	450	1344	145	315	5 - 8	2000	18
A07TR-45	450	1340	90	190	5 - 8	2000	21

Package consists of: multi purpose grab (hydraulic block incl. hosing for HPX)

Available as an option: 4-Grip

Clamshell buckets with HPXdrive

Type	Width (mm)	Opening (mm)	Volume (liter)	Weight (kg)	Operating weight (t)	Load capacity (kg)	Closing force (kN)
C07TR-40 HPX	400	1110	115	295	3 - 7	3000	22
C07TR-50 HPX	500	1110	140	310	3 - 7	3000	22
C07TR-60 HPX	600	1110	170	325	3 - 7	3000	22

Package consists of: clamshell bucket, (hydraulic block incl. hosing for HPX)

Hedge trimmers

Type	Engine power (cc)	Up to diameter max. (mm)	Cutting length (mm)	Weight (kg)	Operating weight (t)
T150-50	50	40	1500	86	1,5 - 2,5
T150-80	80	40	1500	87	2,5 - 4,5

Package consists of: hedge trimmer, frame with adapter for system S-Lock

Ripper teeth

Type	Length (mm)	Thickness (mm)	Weight (kg)	Operating weight (t)
TJR6	600	50	61	<6
TJR8	700	50	130	<8

Package consists of: ripper tooth, frame with adapter for system S-Lock

4-Grip

Type	For grab types	Load capacity (kg)	Weight (kg)	Operating weight (t)
KM 685-05-D04/06-A04/06	D05TR / D07TR / A05TR / A07TR	750	24	<8

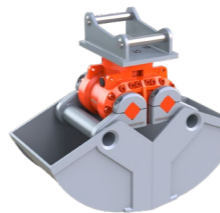
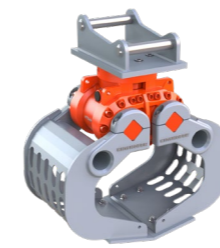

Note: other attachments and adapters on request

Note: other attachments and adapters on request



Bucket sets KIT (SKP/SKD/SKK)

Type	Bucket types	Width (SKP/SKD/SKK) (mm)	Volume (SKP/SKD/SKK) (liter)	Weight (SKP/SKD/SKK) (kg)	Operating weight (t)
KIT 3-S40	SKP 4 / SKD 4 / SKK 4	1100 / 620 / 300	160 / 120 / 60	110 / 80 / 50	<3
KIT 4-S40	SKP 4 / SKD 4 / SKK 4	1200 / 620 / 300	200 / 160 / 60	120 / 80 / 50	<4
KIT 6-S40	SKP 6 / SKD 6 / SKK 6	1300 / 720 / 300	300 / 280 / 160	130 / 140 / 75	<6
KIT 6-S45	SKP 6 / SKD 8 / SKK 10	1300 / 720 / 300	300 / 280 / 160	130 / 140 / 75	<6

Package consists of: grading bucket, backhoe bucket with teeth, cable bucket, adapters system S-Lock

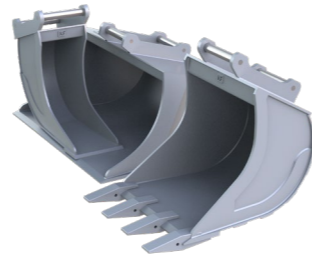

Levelling bars with roller

Type	Width (mm)	Weight (kg)	Operating weight (t)
AVB 8-1800	1800	200	<8
AVB 8-2100	2100	300	<8
AVB 8-2200	2200	420	<8

Package consists of: levelling bar with roller, adapter system S-Lock



Fork tines

Type	Tine adjustment	Load capacity max. (mm)	Width (mm)	Weight (kg)	Operating weight (t)
GAF6	mechanical	1900	1000	140	3 - 6
GAH6	hydraulically	1900	1000	160	3 - 6
GAF8	mechanical	1900	1200	190	6 - 8
GAH8	hydraulically	1900	1200	210	6 - 8

Package consists of: fork tines, frame with adapter for system S-Lock



Compactors

Type	Compactor plate (mm)	Compacting force (t)	Frequency (U/min)	Weight w/o adapter (kg)	Operating weight (t)
KHC08	730 x 318	1,5 - 2,5	2500	225	4 - 8

Package consists of: compactor, adapter system S-Lock

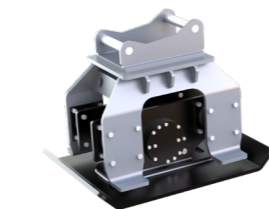

Drum cutters

Type	Torque (Nm @ 350bar)	Cutting force (N)	Nominal power (kW)	Weight Drum cutter (ca. kg)	Operating weight (t)
KDC04-Excavating	2330	13320	18	250	2 - 4
KDC04-Demolition	2330	13320	18	250	2 - 4
KDC04-Profiling	2330	20260	18	250	2 - 4
KDC06-Excavating	2800	16000	18	250	4 - 6
KDC06-Demolition	2800	16000	18	250	4 - 6
KDC06-Profiling	2800	24350	18	250	4 - 6
KDC08-Excavating	3900	22290	22	250	5 - 8
KDC08-Demolition	3900	22290	22	250	5 - 8
KDC08-Profiling	3900	33920	22	250	5 - 8

Package consists of: drum cutter, standard pics, hose set incl. pretension valve in return line



Demolition and sorting grabs with HPXdrive or hydraulic cylinder

Type	Width (mm)	Opening (mm)	Volume (liter)	Weight (kg)	Operating weight (t)	Load capacity form locking (kg)	Closing force (kN)
D05TR-40 HPX	400	1045	75	240	3 - 6	1500	18
D05TR-40	400	1212	60	160	3 - 6	1500	21,5
D07TR-45 HPX	450	1350	150	310	5 - 8	2000	18
D07TR-45	450	1345	90	180	5 - 8	2000	21

Package consists of: demolition and sorting grab (hydraulic block incl. hosing for HPX)

Available as an option: 4-Grip

Multi purpose grabs with HPXdrive or hydraulic cylinder

Type	Width (mm)	Opening (mm)	Volume (liter)	Weight (kg)	Operating weight (t)	Load capacity form locking (kg)	Closing force (kN)
A05TR-40 HPX	400	1043	75	240	3 - 6	1500	18
A05TR-40	400	1233	60	160	3 - 6	1500	21,5
A07TR-45 HPX	450	1344	145	315	5 - 8	2000	18
A07TR-45	450	1340	90	190	5 - 8	2000	21

Package consists of: multi purpose grab (hydraulic block incl. hosing for HPX)

Available as an option: 4-Grip

Clamshell buckets with HPXdrive

Type	Width (mm)	Opening (mm)	Volume (liter)	Weight (kg)	Operating weight (t)	Load capacity (kg)	Closing force (kN)
C07TR-40 HPX	400	1110	115	295	3 - 7	3000	22
C07TR-50 HPX	500	1110	140	310	3 - 7	3000	22
C07TR-60 HPX	600	1110	170	325	3 - 7	3000	22

Package consists of: clamshell bucket, (hydraulic block incl. hosing for HPX)

Hedge trimmers

Type	Engine power (cc)	Up to diameter max. (mm)	Cutting length (mm)	Weight (kg)	Operating weight (t)
T150-50	50	40	1500	86	1,5 - 2,5
T150-80	80	40	1500	87	2,5 - 4,5

Package consists of: hedge trimmer, frame with adapter for system S-Lock

Ripper teeth

Type	Length (mm)	Thickness (mm)	Weight (kg)	Operating weight (t)
TJR6	600	50	61	<6
TJR8	700	50	130	<8

Package consists of: ripper tooth, frame with adapter for system S-Lock

4-Grip

Type	For grab types	Load capacity (kg)	Weight (kg)	Operating weight (t)
KM 685 05-D04/06-A04/06	D05TR / D07TR / A05TR / A07TR	750	24	<8

Note: other attachments and adapters on request

Note: other attachments and adapters on request

Bucket sets KIT (SKP/SKD/SKK)

Type	Bucket types	Width (SKP/SKD/SKK) (mm)	Volume (SKP/SKD/SKK) (liter)	Weight (SKP/SKD/SKK) (kg)	Operating weight (t)
KIT 8-S45	SKP 8 / SKD 10 / SKK 10	1400 / 800 / 400	400 / 350 / 180	180 / 190 / 80	<8
KIT 8-S50	SKP 8 / SKD 10 / SKK 10	1400 / 800 / 400	400 / 350 / 180	180 / 190 / 80	<8
KIT 10-S45	SKP 10 / SKD 10 / SKK 12	1500 / 800 / 400	500 / 450 / 275	210 / 210 / 120	<10
KIT 10-S50	SKP 10 / SKD 10 / SKK 12	1500 / 800 / 400	500 / 450 / 275	210 / 210 / 120	<10

Package consists of: grading bucket, backhoe bucket with teeth, cable bucket, adapters system S-Lock

Levelling bars with roller

Type	Width (mm)	Weight (kg)	Operating weight (t)
AVB 8-1800	1800	200	<8
AVB 8-2100	2100	300	<8
AVB 8-2200	2200	420	<8

Package consists of: levelling bar with roller, adapter system S-Lock

Fork tines

Type	Tine adjustment	Load capacity max. (mm)	Width (mm)	Weight (kg)	Operating weight (t)
GAF8	mechanical	1900	1200	190	6 - 8
GAH8	hydraulically	1900	1200	210	6 - 8
GAF12	mechanical	2500	1200	200	9 - 12
GAH12	hydraulically	2500	1200	220	9 - 12

Package consists of: fork tines, frame with adapter for system S-Lock

Compactors

Type	Compactor plate (mm)	Compacting force (t)	Frequency (U/min)	Weight w/o adapter (kg)	Operating weight (t)
KHC12	920 x 600	2 - 3	2400	290	7 - 12

Package consists of: compactor, adapter system S-Lock

Drum cutters

Type	Torque (Nm @ 350bar)	Cutting force (N)	Nominal power (kW)	Weight Drum cutter (ca. kg)	Operating weight (t)
KDC15-Excavating	5500	27160	30	420	9 - 14
KDC15-Demolition	5500	27160	30	420	9 - 14
KDC15-Profiling	5500	27160	30	420	9 - 14

Package consists of: drum cutter, standard pics, hose set incl. pretension valve in return line

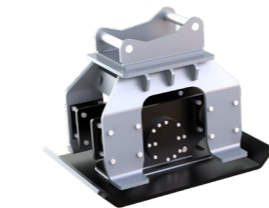
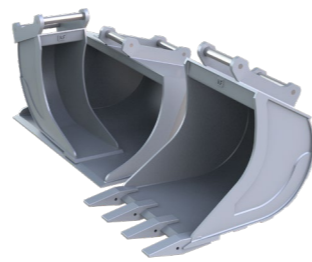

Demolition and sorting grabs with HPXdrive or hydraulic cylinder

Type	Width (mm)	Opening (mm)	Volume (liter)	Weight (kg)	Operating weight (t)	Load capacity form locking (kg)	Closing force (kN)
D11TR-50 HPX	400	1045	75	360	7 - 12	1500	18
D11TR-50	400	1212	60	305	7 - 12	1500	21,5

Package consists of: demolition and sorting grab (hydraulic block incl. hosing for HPX)

Available as an option: 4-Grip

Multi purpose grabs with HPXdrive or hydraulic cylinder

Type	Width (mm)	Opening (mm)	Volume (liter)	Weight (kg)	Operating weight (t)	Load capacity form locking (kg)	Closing force (kN)
A11TR-50 HPX	400	1043	75	365	7 - 12	1500	18
A11TR-50	400	1233	60	310	7 - 12	1500	21,5

Package consists of: multi purpose grab (hydraulic block incl. hosing for HPX)

Available as an option: 4-Grip

Clamshell buckets with HPXdrive

Type	Width (mm)	Opening (mm)	Volume (liter)	Weight (kg)	Operating weight (t)	Load capacity (kg)	Closing force (kN)
C11TR-40 HPX	400	1250	145	265	5 - 11	3000	22
C11TR-50 HPX	500	1250	180	295	5 - 11	3000	22
C11TR-60 HPX	600	1250	220	315	5 - 11	3000	22

Package consists of: clamshell bucket, (hydraulic block incl. hosing for HPX)

Multi-Grip

Type	Width (mm)	Opening (mm)	Volume (m <sup>2</sup> )	Weight (kg)	Operating weight (t)	Load capacity (kg)	Closing force (kN)
MG12	454	1496	0,26	312	9 - 14	6000	22

Package consists of: Multi-Grip, adapter system S-Lock

Hedge trimmers

Type	Engine power (cc)	Up to diameter max. (mm)	Cutting length (mm)	Weight (kg)	Operating weight (t)
T150-100	100	40	1500	88	4,5 - 8

Package consists of: hedge trimmer, frame with adapter for system S-Lock

Ripper teeth

Type	Length (mm)	Thickness (mm)	Weight (kg)	Operating weight (t)
TJR8	700	50	130	<8
TJR12	700	70	160	<12

Package consists of: ripper tooth, frame with adapter for system S-Lock

4-Grip

Type	For grab types	Load capacity (kg)	Weight (kg)	Operating weight (t)
KM 685 05-D09-A09	D11TR /A11TR	750	28	<12

Note: other attachments and adapters on request

Note: other attachments and adapters on request



**Bucket sets KIT (SKP/SKD/SKK)**

Type	Bucket types	Width (SKP/SKD/SKK) (mm)	Volume (SKP/SKD/SKK) (liter)	Weight (SKP/SKD/SKK) (kg)	Operating weight (t)
KIT 12-S45	SKP 12 / SKD 12 / SKK 12	1500 / 800 / 400	550 / 500 / 275	310 / 245 / 120	<12
KIT 12-S50	SKP 12 / SKD 12 / SKK 12	1500 / 800 / 400	550 / 500 / 275	310 / 245 / 120	<12
KIT 14-S60	SKP 14 / SKD 14 / SKK 14	1600 / 900 / 400	600 / 600 / 275	390 / 350 / 120	<14

Package consists of: grading bucket, backhoe bucket with teeth, cable bucket, adapters system S-Lock

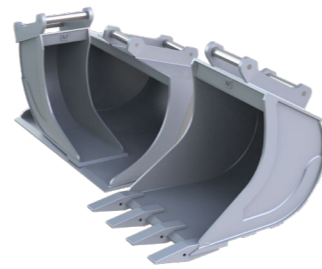

**Levelling bars with roller**

Type	Width (mm)	Weight (kg)	Operating weight (t)
AVB 24-2500	2500	420	<24
AVB 24-2700	2700	470	<24

Package consists of: levelling bar with roller, adapter system S-Lock

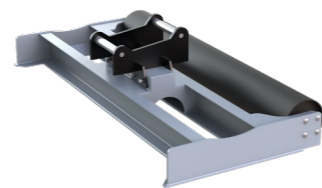

**Fork tines**

Type	Tine adjustment	Load capacity max. (mm)	Width (mm)	Weight (kg)	Operating weight (t)
GAF18	mechanical	4000	1200	340	13 - 18
GAH18	hydraulically	4000	1200	340	13 - 18

Package consists of: fork tines, frame with adapter for system S-Lock



**Compactors**

Type	Compactor plate (mm)	Compacting force (t)	Frequency (U/min)	Weight w/o adapter (kg)	Operating weight (t)
KHC16	1120 x 750	7 - 8	2200	650	10 - 16

Package consists of: compactor, adapter system S-Lock

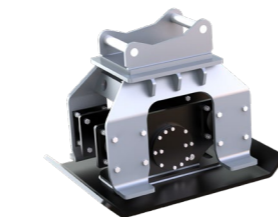

**Drum cutters**

Type	Torque (Nm @ 350bar)	Cutting force (N)	Nominal power (kW)	Weight Drum cutter (ca. kg)	Operating weight (t)
KDC15-Excavating	5500	27160	30	420	9 - 14
KDC15-Demolition	5500	27160	30	420	9 - 14
KDC15-Profiling	5500	27160	30	420	9 - 14

Package consists of: drum cutter, standard pics, hose set incl. pretension valve in return line



**Demolition and sorting grabs**

Type	Width (mm)	Opening (mm)	Volume (liter)	Weight (kg)	Operating weight (t)	Load capacity (kg)	Closing force (kN)
D14TR-60	600	1555	260	400	11 - 19	3000	30

Package consists of: demolition and sorting grab

**Multi purpose grabs**

Type	Width (mm)	Opening (mm)	Volume (liter)	Weight (kg)	Operating weight (t)	Load capacity (kg)	Closing force (kN)
A14TR-60	600	1890	260	510	11 - 19	3000	30

Package consists of: multi purpose grab

**Multi-Grip**

Type	Width (mm)	Opening (mm)	Volume (m <sup>2</sup> )	Weight (kg)	Operating weight (t)	Load capacity (kg)	Closing force (kN)
MG16	531	1822	0,36	474	12 - 18	8000	27

Package consists of: Multi-Grip, adapter system S-Lock

**Ripper teeth**

Type	Length (mm)	Thickness (mm)	Weight (kg)	Operating weight (t)
TJR12	700	70	160	<12
TJR14	900	70	250	<14

Package consists of: ripper tooth, frame with adapter for system S-Lock

Note: other attachments and adapters on request

Note: other attachments and adapters on request

Bucket sets KIT (SKP/SKD/SKK)

Type	Bucket types	Width (SKP/SKD/SKK) (mm)	Volume (SKP/SKD/SKK) (liter)	Weight (SKP/SKD/SKK) (kg)	Operating weight (t)
KIT 16-S60	SKP 16 / SKD 16 / SKK 16	1600 / 900 / 400	650 / 650 / 340	500 / 400 / 270	<16
KIT 18-S60	SKP 18 / SKD 18 / SKK 18	1700 / 900 / 500	750 / 700 / 380	520 / 440 / 280	<18

Package consists of: grading bucket, backhoe bucket with teeth, cable bucket, adapters system S-Lock

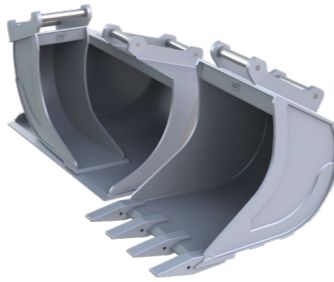

Demolition and sorting grabs

Type	Width (mm)	Opening (mm)	Volume (liter)	Weight (kg)	Operating weight (t)	Load capacity (kg)	Closing force (kN)
D19TR-80	800	1550	300	500	11 - 19	4000	27

Package consists of: demolition and sorting grab

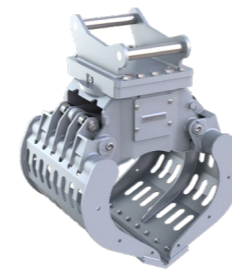

Levelling bars with roller

Type	Width (mm)	Weight (kg)	Operating weight (t)
AVB 24-2500	2500	420	<24
AVB 24-2700	2700	470	<24

Package consists of: levelling bar with roller, adapter system S-Lock

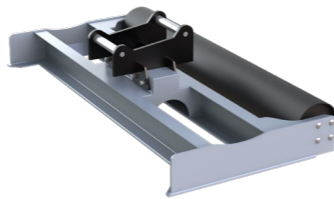

Multi purpose grabs

Type	Width (mm)	Opening (mm)	Volume (liter)	Weight (kg)	Operating weight (t)	Load capacity (kg)	Closing force (kN)
A19TR-60	600	1900	300	570	11 - 19	4000	27

Package consists of: multi purpose grab

Fork tines

Type	Tine adjustment	Load capacity max. (mm)	Width (mm)	Weight (kg)	Operating weight (t)
GAF18	mechanical	4000	1200	340	13 - 18
GAH18	hydraulically	4000	1200	340	13 - 18
GAF20	mechanical	4000	1200	420	19 - 20
GAH20	hydraulically	4000	1200	420	19 - 20

Package consists of: fork tines, frame with adapter for system S-Lock



Multi-Grip

Type	Width (mm)	Opening (mm)	Volume (m <sup>2</sup> )	Weight (kg)	Operating weight (t)	Load capacity (kg)	Closing force (kN)
MG16	531	1822	0,36	474	12 - 18	8000	27
MG20	531	2279	0,52	560	16 - 22	10000	33

Package consists of: Multi-Grip, adapter system S-Lock

Compactors

Type	Compactor plate (mm)	Compacting force (t)	Frequency (U/min)	Weight w/o adapter (kg)	Operating weight (t)
KHC25	1270 x 950	9 - 11	2000	840	14 - 25

Package consists of: compactor, adapter system S-Lock

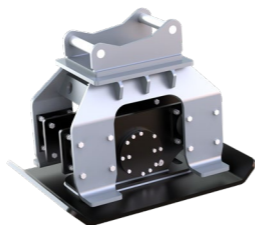

Ripper teeth

Type	Length (mm)	Thickness (mm)	Weight (kg)	Operating weight (t)
TJR20	1000	100	390	<20

Package consists of: ripper tooth, frame with adapter for system S-Lock

Drum cutters

Type	Torque (Nm @ 350bar)	Cutting force (N)	Nominal power (kW)	Weight Drum cutter (ca. kg)	Operating weight (t)
KDC20-Excavating	9900	36000	45	850	12 - 20
KDC20-Demolition	9900	36000	45	850	12 - 20
KDC20-Profiling	9900	42580	45	850	12 - 20
KDC30-Excavating	14000	45530	60	1400	18 - 30
KDC30-Demolition	14000	45530	60	1400	18 - 30
KDC30-Profiling	14000	45530	60	1400	18 - 30

Package consists of: drum cutter, standard pics, hose set incl. pretension valve in return line



Note: other attachments and adapters on request

Note: other attachments and adapters on request



Bucket sets KIT (SKP/SKD/SKK)

Type	Bucket types	Width (SKP/SKD/SKK) (mm)	Volume (SKP/SKD/SKK) (liter)	Weight (SKP/SKD/SKK) (kg)	Operating weight (t)
KIT 20-S70	SKP 20 / SKD 20 / SKK 18	1600 / 900 / 500	950 / 850 / 380	550 / 550 / 310	<20
KIT 22-S70	SKP 22 / SKD 22 / SKK 22	1800 / 1000 / 500	1000 / 1100 / 380	670 / 850 / 310	<22
KIT 24-S70	SKP 24 / SKD 24 / SKK 24	1800 / 1000 / 600	1200 / 1200 / 500	780 / 950 / 500	<24

Package consists of: grading bucket, backhoe bucket with teeth, cable bucket, adapters system S-Lock

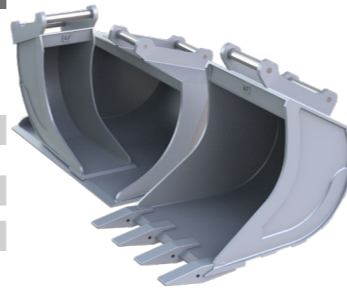

Levelling bars with roller

Type	Width (mm)	Weight (kg)	Operating weight (t)
AVB 24-2500	2500	420	<24
AVB 24-2700	2700	470	<24

Package consists of: levelling bar with roller, adapter system S-Lock



Fork tines

Type	Tine adjustment	Load capacity max. (mm)	Width (mm)	Weight (kg)	Operating weight (t)
GAF20	mechanical	4000	1200	420	19 - 20
GAH20	hydraulically	4000	1200	420	19 - 20
GAF24	mechanical	5000	1200	440	21 - 24
GAH24	hydraulically	5000	1200	440	21 - 24

Package consists of: fork tines, frame with adapter for system S-Lock



Compactors

Type	Compactor plate (mm)	Compacting force (t)	Frequency (U/min)	Weight w/o adapter (kg)	Operating weight (t)
KHC25	1270 x 950	9 - 11	2000	840	14 - 25
KHC35	1290 x 1000	10 - 15	2000	1020	18 - 35

Package consists of: compactor, adapter system S-Lock

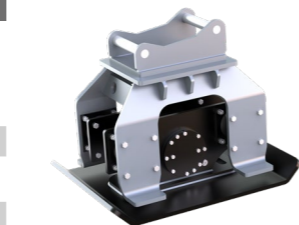

Drum cutters

Type	Torque (Nm @ 350bar)	Cutting force (N)	Nominal power (kW)	Weight Drum cutter (ca. kg)	Operating weight (t)
KDC30-Excavating	14000	45530	60	1400	18 - 30
KDC30-Demolition	14000	45530	60	1400	18 - 30
KDC30-Profiling	14000	45530	60	1400	18 - 30

Package consists of: drum cutter, standard pics, hose set incl. pretension valve in return line



Note: other attachments and adapters on request

Demolition and sorting grabs

Type	Width (mm)	Opening (mm)	Volume (liter)	Weight (kg)	Operating weight (t)	Load capacity (kg)	Closing force (kN)
D25TR-84	840	1890	380	725	18 - 25	5000	42

Package consists of: demolition and sorting grab



Multi purpose grabs

Type	Width (mm)	Opening (mm)	Volume (liter)	Weight (kg)	Operating weight (t)	Load capacity (kg)	Closing force (kN)
A25TR-84	700	2038	400	815	18 - 25	5000	38

Package consists of: multi purpose grab

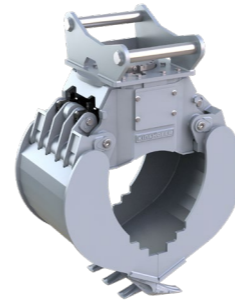

Multi-Grip

Type	Width (mm)	Opening (mm)	Volume (m²)	Weight (kg)	Operating weight (t)	Load capacity (kg)	Closing force (kN)
MG20	531	2279	0,52	560	16 - 22	10000	33

Package consists of: Multi-Grip, adapter system S-Lock



Ripper teeth

Type	Length (mm)	Thickness (mm)	Weight (kg)	Operating weight (t)
TJR24	1000	100	390	<24

Package consists of: ripper tooth, frame with adapter for system S-Lock



Note: other attachments and adapters on request

---

---

---

---

---

---



---

---

---

---

---

---





## CONTACT

### KINSHOFER Branches

**Hauptsitz Deutschland:**  
**KINSHOFER** GmbH  
Raiffeisenstrasse 12  
83607 Holzkirchen  
Tel.: +49 (0) 8021 88 99 0  
Fax: +49 (0) 8021 88 99 37  
Email: [info@kinshofer.com](mailto:info@kinshofer.com)  
[www.kinshofer.com](http://www.kinshofer.com)

**United Kingdom:**  
**KINSHOFER** UK Ltd.  
4 Milton Industrial Court  
Horsfield Way, Bredbury  
Stockport, Cheshire, SK6 2TA  
Tel.: +44 (0) 161 406 7046  
Fax: +44 (0) 161 406 7014  
Email: [sales-uk@kinshofer.com](mailto:sales-uk@kinshofer.com)  
[www.kinshofer.com](http://www.kinshofer.com)

**France:**  
**KINSHOFER** France S.A.R.L.  
8 Bis, rue Gabriel Voisin, CS 40003  
F-51688 Reims Cedex 2  
Tel.: +33 (0) 3 88 39 55 00  
Fax: +33 (0) 3 88 79 06 75  
Email: [sales-france@kinshofer.com](mailto:sales-france@kinshofer.com)  
[www.kinshofer.com](http://www.kinshofer.com)

**Canada:**  
**KINSHOFER** North America  
5040 Mainway Drive, Unit #11  
Burlington, ON L7L 7G5  
Tel.: +1 (905) 335-2856  
Fax: +1 (905) 335-4529  
Toll Free (North America): 1-800-268-9525  
Email: [sales-northamerica@kinshofer.com](mailto:sales-northamerica@kinshofer.com)  
[www.kinshofer.com](http://www.kinshofer.com)

**United States of America:**  
**KINSHOFER** USA  
6420 Inducon Drive  
Suite G  
Sanborn, NY, 14132  
Tel.: +1 (716) 731-4333  
Toll Free (North America): 1-800-268-9525  
Email: [sales-usa@kinshofer.com](mailto:sales-usa@kinshofer.com)  
[www.kinshofer.com](http://www.kinshofer.com)



Part of the  
**KINSHOFER**  
Group

[kinshofer.com](http://kinshofer.com)



**KINSHOFER** is an ISO 9001 certified Company. DVS ZERT is a registered trademark of DVS ZERT® e.V., Düsseldorf.

### KINSHOFER Subsidiaries

**Nederland:**  
**DEMAREC Demolition and Recycling Equipment B.V.**  
De Hork 32  
NL-5431 NS Cuijk  
Tel.: +31 (0) 485 442300  
Fax: +31 (0) 485 442120  
[info@demarec.com](mailto:info@demarec.com)  
[www.demarec.com](http://www.demarec.com)

**Sverige:**  
**RF System AB**  
Furutorpsgatan 6  
SE-288 34 Vinslöv  
Tel.: +46 (0) 44 817 07  
Fax: +46 (0) 44 859 63  
Email: [info@rf-system.se](mailto:info@rf-system.se)  
[www.rf-system.se](http://www.rf-system.se)

**United Kingdom:**  
**Auger Torque Europe Limited**  
Hazleton  
Cheltenham, GL54 4DX  
Tel.: +44 (0) 1451 861 652  
Fax: +44 (0) 1451 861 660  
Email: [sales@augertorque.com](mailto:sales@augertorque.com)  
[www.augertorque.com](http://www.augertorque.com)

**Australia:**  
**Auger Torque Australia Pty Ltd.**  
122 Boundary Road, Rocklea  
Queensland 4106  
Tel.: +61 (0) 7 3274 2077  
Fax: +61 (0) 7 3274 5077  
Email: [sales@augertorque.com.au](mailto:sales@augertorque.com.au)  
[www.augertorque.com.au](http://www.augertorque.com.au)

**Doherty Couplers & Attachments Ltd.**  
PO Box 701,  
Annerley (Brisbane) QLD, 4103  
Tel.: +61 1 800 057 021  
Email: [sales@dohertydirect.net](mailto:sales@dohertydirect.net)  
[www.dohertydirect.net](http://www.dohertydirect.net)

**New Zealand:**  
**Doherty Engineered Attachments Ltd.**  
PO Box 9339, Greerton  
Tauranga 3142  
Tel.: +64 7 574 3000  
Fax: +64 7 574 8030  
Email: [sales@dohertydirect.net](mailto:sales@dohertydirect.net)  
[www.dohertydirect.net](http://www.dohertydirect.net)

**United States of America:**  
**Solesbee's Equipment & Attachments, LLC**  
2640 Jason Industrial Parkway  
Winston, GA 30187  
Toll Free (North America): 1-800-419-8090  
Email: [sales@solesbees.com](mailto:sales@solesbees.com)  
[www.solesbees.com](http://www.solesbees.com)

**中国:**  
**Auger Torque China CO., Ltd.**  
Baozhan Rd, Tongyi Industry Zone  
Dongwu, Yinzhou, Ningbo  
China 315114  
Tel.: + 86 (0) 574 8848 8181  
Fax: + 86 (0) 574 8848 8687  
Email: [john.hu@attachmenttorque.com](mailto:john.hu@attachmenttorque.com)  
[www.augertorque.com](http://www.augertorque.com)

**Italia:**  
**Hammer S.r.l.**  
Via Oleifici dell' Italia Meridionale, lotto G1  
IT-70056 Molfetta BA  
Tel.: +39 080 337 5317  
Email: [info@hammer.eu](mailto:info@hammer.eu)  
[www.hammereurope.com](http://www.hammereurope.com)